

# APOLLO

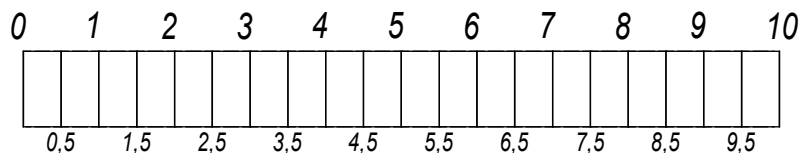

<p><i>e - 078 (x kpl)</i></p>	<p><i>e - 133 (x8)</i></p>	<p><i>e - 124</i></p> <p>"4"</p>	<p><i>e - 079 (x2)</i></p> <p>800N - 140 1000N - 160 1150N - 180</p>	<p><i>e - 156 (x2)</i></p>	<p><i>e - 213 (x4)</i></p>	<p><i>e - 081 (x12)</i></p> <p>8</p>
<p><i>e - 139 (x8)</i></p> <p>M6x20</p>	<p><i>e - 112 (x4)</i></p> <p>5x30</p>	<p><i>e - 128 (x8)</i></p> <p>M6x50</p>	<p><i>e - 082 (x12)</i></p> <p>M8x20</p>	<p><i>e - 212 (x16)</i></p> <p>M8x25</p>	<p><i>e - 155 (x16)</i></p> <p>M8x30</p>	<p><i>e - 126 (x14)</i></p> <p>4x20</p>

AP-100-099

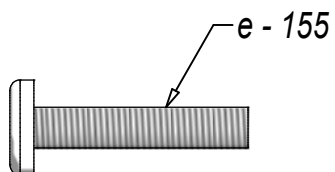
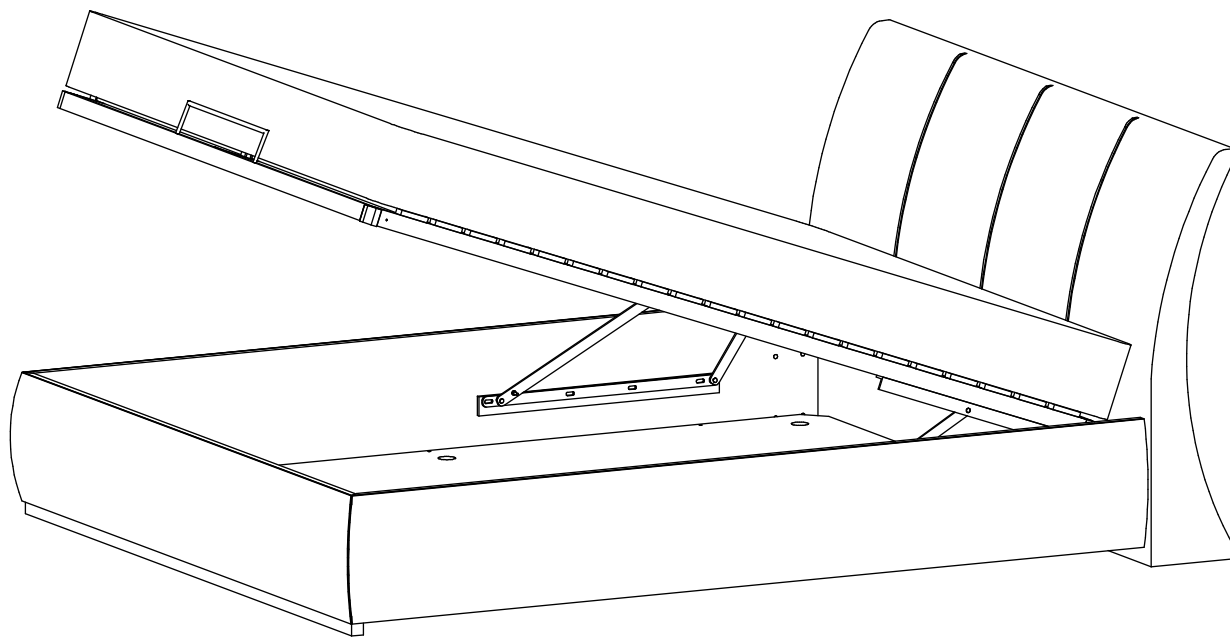
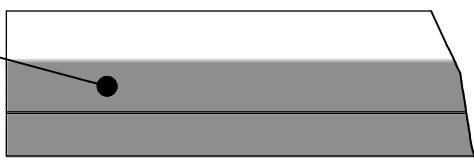

AP-100-099

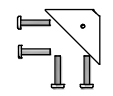
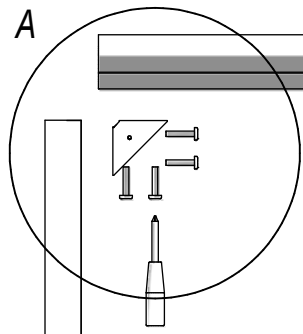
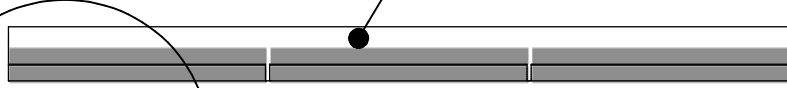

e-133

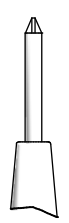
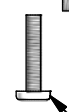
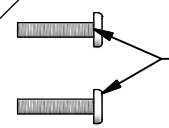
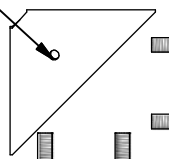
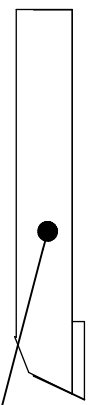

e-212

e-155

AP-100-002

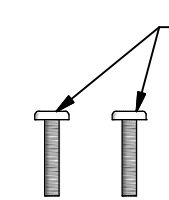
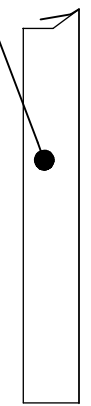

e-155

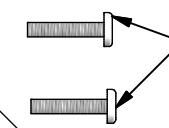
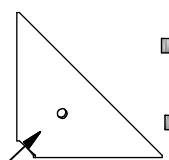

e-212

e-133

AP-100-001

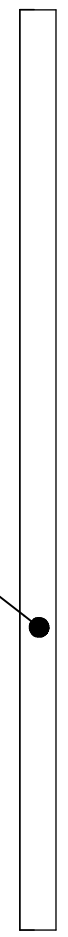

AP-100-002

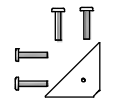
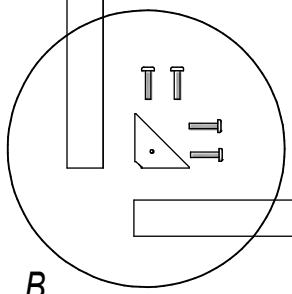

AP-100-098

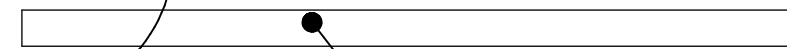

AP-100-098

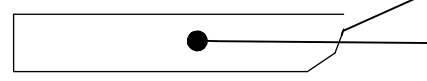

B

A

